



**Product Code**

**VP30031**

**16A 3P+N+E Industrial Plug IP67**

★ Rated current:16A
★ Rated voltage: 220-380V/240-415V
★ No. of poles:3P+N+E
★ Protection degree: IP67
★ Housing material: Flame Retardant PA6 RoHS Reach Contact: nickel-plated brass RoHS Reach
★ Standards: IEC60309-1, IEC60309-2
★ Certificates: S,CB,CE,TUV,ISO9001:2008,RoHS,REACH

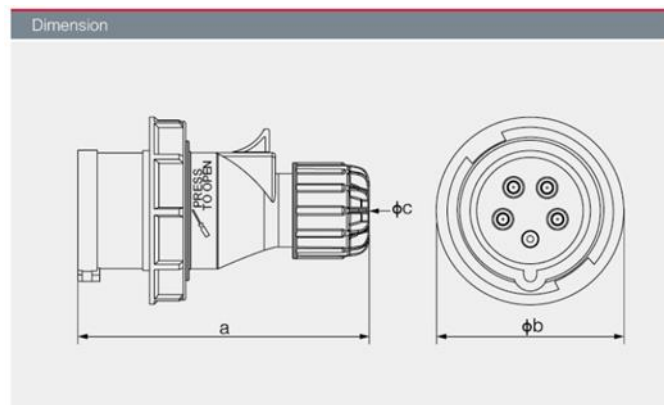

Current	16A			32A			
	Pole	3	4	5	3	4	5
a		120	125	133	150	150	155
b		71	79	87	93	93	99.5
c		15	15	17	22	22	22
Cable size(mm <sup>2</sup> )		1-2.5			2.5-6		

